



























ostim
etiket.

etiket
üretim
sanayi

“yol güvenliği”

2022

Trafik Güvenlik Sistemleri

	Güvenlik Bariyerleri	06
	Güvenlik Barikatları	06
	Katlanır Uyarı Levhalı Bariyerler	07
	Katlanır Uyarı Levhaları	07
	Dubalı Uyarı Levhalı Bariyerler	07
	Dubalı Uyarı Dikmeleri / Dubalı Ultra Uyarı Dikmeleri	08
	Ultra Levhalı Uyarı Dubaları	08
	Esnek Uyarı Levhası	08
	Solar Flaşörlü LED'li Lambalar	09
	Solar LED'li Siperlikli Lambalar	10
	Solar Ledli Flaşörlü Lambalar / AC LED'li Lamba ve İşaretlemeler	10
	Solar LED'li Yol Bakım Levhaları	10
	Solar Flaşörlü LED'li Trafik Levhaları	11
	AC/LED'li Yol Bakım Levhaları	11
	Solar LED'li Yol Bakım Levhaları	12 - 13
	PVC Trafik Konileri (90 cm)	14
	PVC Trafik Konileri (75 / 50 / 32 cm)	14
	PVC Trafik Konileri (70 / 50 cm)	14
	PVC Trafik Konileri (60 / 50 cm)	14
	TPE Trafik Konileri (90 / 75 / 70 / 50 cm)	15
	Klasik Kedi Gözlü Trafik Konileri / Ultra Kedi Gözlü / Eko Trafik Konileri	15
	Ultra Levhalı Reklam Dubaları / Reklam Dubaları ve Levhaları	15
	Esnek Refüj Başı Levhaları	16
	TPU Şerit Ayırıcı Esnek Delinatörler	16 - 17
	TPE Şerit Ayırıcı Esnek Delinatörler	17
	TPU Şerit Ayırıcı Esnek Delinatörler (Soketli)	17

	Demonte Delinatörler	18
	Delinatörlü ve Levhalı Şerit Düzenleme Butonları	18
	Levhalı Şerit Düzenleme Butonları	18
	Levhalı Esnek Delinatörler	18
	Şerit Sınırlama Butonları	18 - 19
	Şerit Sınırlama Butonu (Solar Butonlu)	19
	Solar Yol İşaretleme Butonları	19
	Cam Kedi Gözlü Yol Butonları / Mercekli Yol Butonları	19
	Yol Kasisleri (Reflektif Bantlı)	20
	Yol Kasisleri (Reflektif Lensli)	20
	Yol Kasisleri / (Kedigözlü)	20
	Yol Kasisleri / (Reflektif Lensli)	20
	Yol Kasisleri / (Solar)	20
	Araç Stoperleri	21
	Otopark Kasis Kapanı	21
	Kablo ve Hortum Koruyucu Kasis ve Köşesi	21
	Otopark Kolon Köşe Koruyucular	22
	Trafik Güvenlik Aynaları	22
	Refüj Dubaları / Demonte Refüj Dubaları / Anti-Park Dubaları	23
	Görme Engelli Zemin İşaretleme	24
	Yapışkanlı Zemin Uyarı İşaretleri	25
	Yapışkanlı Zemin İşaretleme Bantları	26 - 27
	Trafik Levhaları	28 - 29
	Uyarı Levhaları	29
	Koni / Delinatör / Dikme Aksesuarları	29
	Barikat aksesuarları	29

Güvenlik Bariyerleri

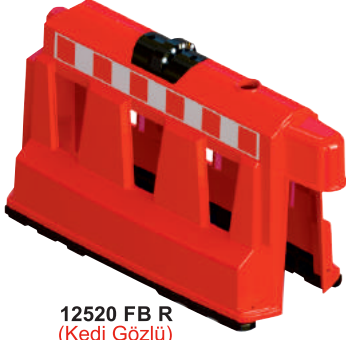
12520 FB R
(Kedi Gözlü)12526 FB R
(Solar Flaşörlü)12524 FB R
(Delinatörlü)12522 FB R
(Uyarı Levhalı)

Ürün Teknik Özellikleri

Kod	12520 FB R	12526 FB R	12524 FB R	12522 FB R
Ölçü(HxLxW) ±%5	60x100x40cm	60x100x40cm	60x100x40cm	60x100x40cm
Ölçü(lens/delinatör/levha)	-	Lens Ø10 cm	(HxØ)45x8.0cm TPU	(HxL)50x12cm
Ağırlık ±%5	20.0 kg	20.0 kg	20.0 kg	20.0 kg
Malzeme(Gövde-Taban)	PPC-PVC	PPC-PVC	PPC-PVC	PPC-PVC

Güvenlik Barikatları



12510 FB R



12512 FB R

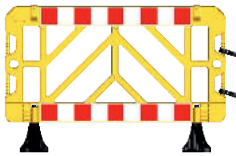

12514 FB R

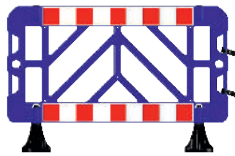

12516 FB R

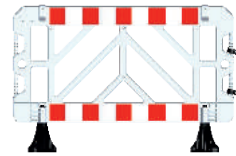

12518 FB R

Ürün Teknik Özellikleri

Kod	12510 FB R 12514 FB R 12516 FB R 12518 FB R	12512 FB R
Ölçü(HxLxW) ±%5	100x150x50cm	100x150x50cm
Levha(HxL)	-	52x101.5cm
Ağırlık ±%5	12.0 kg	12.3 kg
Malzeme(Gövde-Taban)	PPC-PVC	PPC-PVC

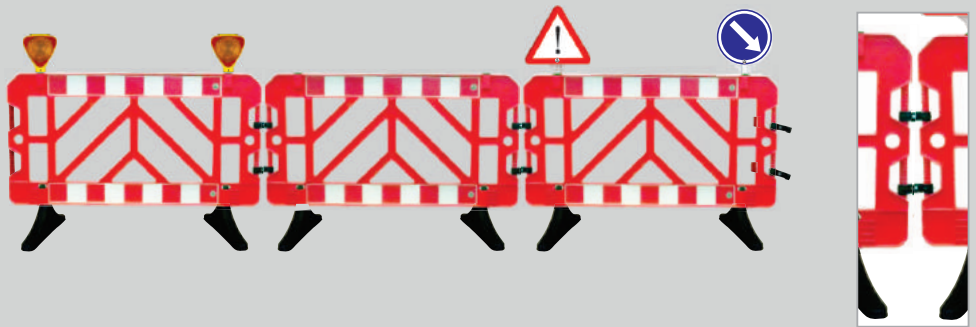

Ayaklar 90° çevrilerek taşıma kolaylığı ve istifleme avantajı sağlar.

Katlanır Uyarı Levhaları Bariyerler



12500 FB R



12501 FB R



12503 FB R

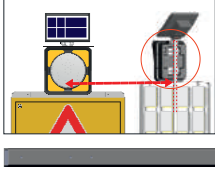

12504 FB R

191 A
(4x2x80 cm-Lamba Profili)

REFLEKTİF ASTM D 4956-11a Type I

Ürün Teknik Özellikleri

Kod	12500 FB R	191 A - (Lam.Profil)	12501 FB R	12503 FB R	12504 FB R
Ölçü Bariyer (HxL) ±%5	150x90 cm	(HxLxW)4.0x80x2.0cm	91x100cm	110x42 cm	110x236 cm
Levha (HxL)	90x90 cm	-	31.5x90 cm	90x31.5 cm	75x125 cm
Ağırlık ±%5	18.0 kg	1.4 kg	20.0 kg	15.5 kg	37.0 kg
Malzeme(Gövde/Levha)	PPC-PVC	Metal	PPC-PVC	PPC-PVC	PPC-PVC

Katlanır Uyarı Levhaları

12500 FB R / 12417 DB R
Levha Uygulamaları

REFLEKTİF ASTM D 4956-11a Type I



12417 DB R



12410 DB R



12415 DB R



12416 DB R

REFLEKTİF TS EN 13422+A1



Ürün Teknik Özellikleri

Kod	12417 DB R	12410 DB R	12415 DB R	12416 DB R
Ölçü Bariyer (HxLxW) ±%5	90x60x48 cm	120x27x48 cm	104x22x48 cm	72x22x45 cm
Ölçü Panel (WxH)	60x60 cm	100x25 cm	80x20 cm	48x20 cm
Ağırlık ±%5	12.0 kg	12.0 kg	11.0 kg	6.5 kg
Malzeme(Levha/Taban)	PPC-PVC	PPC-PVC	PPC-PVC	PPC-PVC

Dubalı Uyarı Levhaları Bariyerler



12405 DB R

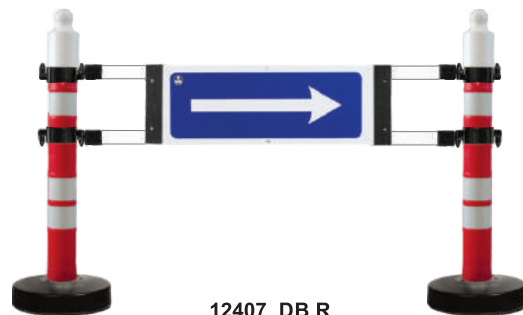

12407 DB R



Şekil 1



Şekil 2



Şekil 3



Şekil 1



Şekil 2



Şekil 3

REFLEKTİF ASTM D 4956-11a Type I

Ürün Teknik Özellikleri

Kod	12405 DB R	12407 DB R
Ölçü Bariyer (HxL) ±%5	120x180 cm	120x180 cm
Levha (HxL)	75x125 cm	31.5x90 cm
Ağırlık ±%5	31.0 kg	27.0 kg
Malzeme(Dikme/Levha)	PPC-PVC	PPC-PVC

Dubalı Uyarı Dikmeleri

Dubalı Ultra Uyarı Dikmeleri



12402 DB 12404 DB R 12414 DB R



12428 DB 12430 DB R

REFLEKTİF ASTM D 4956-11a Type I

- » Esnek kırılmaz taban, Taşıma kolaylığı
- » Üst üste geçme, istiflemeye daha az alan
- » Flaşör lamba, Uyarı levhası, Zincir takma

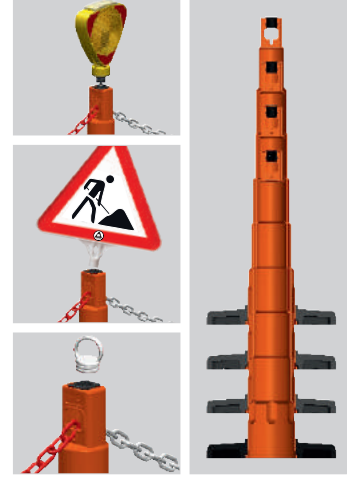

Ürün Teknik Özellikleri

Kod	12402 DB	12404 DB R	12414 DB R	12428 DB	12430 DB R
Ölçü (HxØ) ±%5	120x11 cm	120x11 cm	120x11 cm	120x14 cm	120x14 cm
Taban (HxL) ±%5	9.5x40cm	9.5x40cm	9.5x40cm	6.0x50cm	6.0x50cm
Ağırlık ±%5	12.0 kg	12.0 kg	12.0 kg	8.7 kg	8.7 kg
Malzeme(Gövde/Taban)	PPC	PPC	PPC	PPC-PVC	PPC-PVC

Dubalı Uyarı Dikmeleri



12401-1 DB 12403-1 DB R (Ø63 mm) 12409-1 DB R

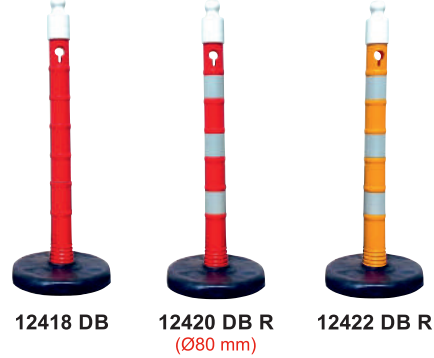

12418 DB 12420 DB R (Ø80 mm) 12422 DB R

Ürün Teknik Özellikleri

Kod	12401-1 DB	12403-1 DB R	12409-1 DB R	12418 DB	12420 DB R	12422 DB R
Ölçü (HxØ) ±%5	100x6.3cm	100x6.3cm	100x6.3cm	110x8.0 cm	110x8.0 cm	110x8.0 cm
Taban (HxL) ±%5	7.5x40cm	7.5x40cm	7.5x40cm	7.0x40cm	7.0x40cm	7.0x40cm
Ağırlık ±%5	4.0 kg	4.0 kg	4.0 kg	6.5 kg	6.5 kg	6.5 kg
Malzeme(Gövde/Taban)	PPC-PVC	PPC-PVC	PPC-PVC	PPC-PVC	PPC-PVC	PPC-PVC

Ultra Levhalı Uyarı Dubaları

Esnek Uyarı Levhası

12423 DB R A
(Tek Yönde Uyarı)12425 DB R A
(İki Yönde Uyarı)

12423 DB R A - Levha Uygulamaları



Şekil 1

Şekil 2

Şekil 3



Şekil 1

Şekil 2

12413 DB R
(İki Yönlü Uyarı)

REFLEKTİF ASTM D 4956-11a Type I

TS EN 13422+A1

- » Kolay taşınabilir pratik gövde
- » Yan yüzeylerde zincir geçirme kanalı
- » Ağırlıklı taban ile devrilmeye karşı güçlü mukavemet
- » Yıvıli, lamba/levha takma yuvası
- » Lamba ve levha takılabilme özelliği ile daha etkin uyarı

Ürün Teknik Özellikleri

Kod	12423 DB R A	12425 DB R A	12413 DB R
Ölçü (HxLxW) ±%5	90x49.5x39.5cm	90x49.5x39.5cm	75x12cm
Etiket (HxL) ±%5	60x40 cm	60x40 cm	40x10 cm
Ağırlık ±%5	7.5 kg	7.5 kg	4.5 kg
Malzeme(Gövde/Taban)	PPC-PVC	PPC-PVC	TPU-PVC

Solar Flaşörlü LED'li Lambalar



11811 FL S



11813 FL K



11825 FL S



11827 FL K



Elektronik Devre Teknik Özellikler

Solar Panel	Tip	monocrystalline silicon cell
	Ölçü (HxL)±%5	45x120 mm
	Voltaj	4 V
Şarjlı Pil	Watt	0.6 W
	Malzeme	Ni-MH
LED	Voltaj	2x1.2 V
	Akım	2000 mA/h
	Renk	Sarı-Kırmızı
	Ölçü	(Ø 5 mm)
	Flaş Sayısı	105 f/dk
	Uyarı Mesafesi	200 m (gece)
	Çalışma Süresi	Gün ışığında şarj ile tüm gece
	Çalışma Sıcaklığı	-20°C/+60°C

Ürün Teknik Özellikleri

Kod	11811 FL S	11813 FL K	11825 FL S	11827 FL K
Ölçü (HxLxW) ±%5	29x23.5x9.0 cm	29x23.5x9.0 cm	29x21.5x9.0 cm	29x21.5x9.0 cm
Flaş Lens ±%5	Ø16 cm	Ø16 cm	Ø16 cm	Ø16 cm
Ağırlık ±%5	0.84 kg	0.84 kg	0.75 kg	0.75 kg
Malzeme(Gövde-Lens)	ABS - PC	ABS - PC	ABS - PC	ABS - PC

Solar Flaşörlü LED'li Lambalar



11814 FL S



11816 FL K



11817 FL K



11819 FL S



11821 FL M

Elektronik Devre Teknik Özellikler

Solar Panel	Tip	monocrystalline silicon cell
	Ölçü (HxL)±%5	45x120 - 54x60mm
	Voltaj	4 V - 3 V
Şarjlı Pil	Watt	0.6 W - 0.4 W
	Malzeme	Ni-MH
LED	Voltaj	1.2 V
	Akım	2000 mA/h
	Renk	Sarı-Kırmızı-Mavi
	Ölçü	(Ø 5 mm)
	Flaş Sayısı	105 f/dk - 115 f/dk
	Uyarı Mesafesi	200m/100 m (gece)
	Çalışma Süresi	Gün ışığında şarj ile tüm gece
	Çalışma Sıcaklığı	-20°C/+60°C

Ürün Teknik Özellikleri

Kod	11814 FL S	11816 FL K	11817 FL K	11819 FL S	11821 FL M
Ölçü ±%5	(HxLxW)27x22x8.0cm	(HxLxW)27x22x8.0cm	(HxØ)14.5x12.8cm	(HxØ)14.5x12.8cm	(HxØ)14.5x12.8cm
Flaş Lens ±%5	Ø16 cm	Ø16 cm	(HxØ)4.5x12 cm	(HxØ)4.5x12 cm	(HxØ)4.5x12 cm
Ağırlık ±%5	0.50 kg	0.50 kg	0.35 kg	0.35 kg	0.35 kg
Malzeme(Gövde-Lens)	ABS - PC	ABS - PC	PC	PC	PC

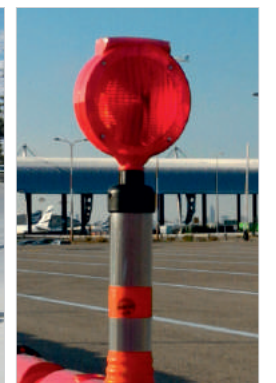

Solar LED'li Siperlikli Lambalar

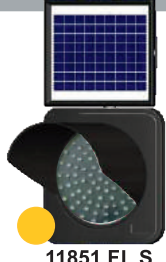

11851 FL S

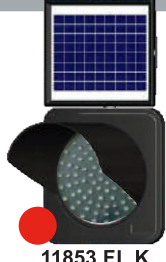

11853 FL K



11850 FL S



11852 FL K

Ürün Teknik Özellikleri

Kod	11851 FL S	11853 FL K	11850 FL S	11852 FL K
Ölçü-Gövde (HxL) ±%5	40x40 cm	40x40 cm	40x40 cm	40x40 cm
Ölçü-lens (Ø)/işaret(HxL)	Ø30 cm	Ø30 cm	Ø30 cm	Ø30 cm
Ağırlık ±%5	8.0 kg	8.0 kg	7.3 kg	7.3 kg
Malzeme(Gövde-Zemin)	PC			

Solar LED'li Flaşör Lambalar

Elektronik Devre Teknik Özellikler

Solar Panel	Tip	Glass Laminated
	Ölçü (HxL)±%5	293x345 mm
	Voltaj	18 V
Jel Akü	Watt	10 W
	Malzeme	SLA
LED	Voltaj	12 V
	Akım	7.0 A/h
	Renk	Sarı-Kırmızı
	Ölçü (Ø10-5mm)	x102 Led-x72 Led
	Flaş Sayısı	65 f/dk
	Uyarı Mesafesi	500 m (gece)
	Çalışma Süresi	Gün ışığında şarj ile tüm gece
	Çalışma Sıcaklığı	-20°C/+60°C

Solar LED'li Flaşör Lambalar



11860 FL S

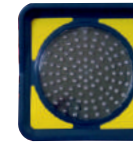

11862 FL S

11882 FL A Sağ Yön
11883 FL A Sol Yön

11885 FL A

Ürün Teknik Özellikleri

Kod	11860 FL S	11862 FL S	11882 FL A	11883 FL A	11885 FL A
Ölçü-Gövde (LxW) ±%5	40x40 cm	40x40 cm	40x40 cm	40x40 cm	40x40 cm
Flaş Lens ±%5	32x32 cm	32x32 cm	32x32 cm	32x32 cm	Ø30 cm
Ağırlık ±%5	7.0 kg	7.0 kg	2.8 kg	2.8 kg	3.1 kg
Malzeme(Gövde-Zemin)	PC-Kompozit Panel				PC

AC LED'li Lamba ve İşaretlemeler

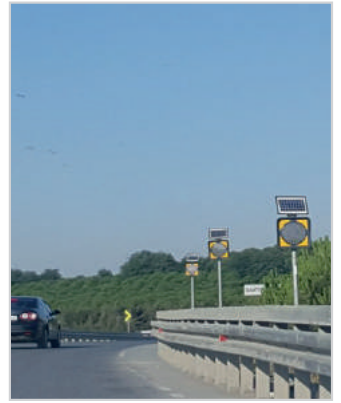

Solar LED'li Yol Bakım Levhaları

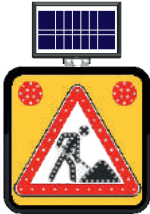

11835 FL



11836 FL



11843 FL



11844 FL



11845 FL

Ürün Teknik Özellikleri

Kod	11835 FL	11836 FL	11843 FL	11844 FL	11845 FL
Ölçü(HxL) ±%5	60x60cm	60x60cm	60x60cm	60x60cm	60x60cm
Ağırlık ±%5	9.8 kg	9.8 kg	9.8 kg	9.8 kg	9.8 kg
Malzeme(Gövde/Zemin)	PC-Kompozit Panel				

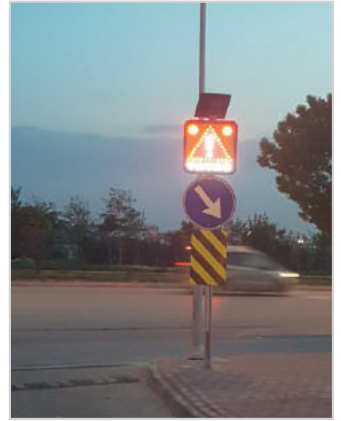
11832 FL (Sol Yön)
11831 FL (Sağ Yön)

11833 FL

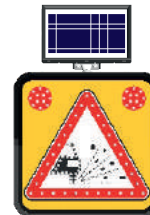
11848 FL (Sağ yön)
11847 FL (Sol Yön)

11837 FL



11800-38 FL

Ürün Teknik Özellikleri

Kod	11832 FL	11831 FL	11833 FL	11848 FL	11847 FL	11837 FL	11800-38 FL
Ölçü(HxL) ±%5	60x60cm	60x60cm	60x60cm	60x60cm	60x60cm	60x60cm	60x60cm
Ağırlık ±%5	9.8 kg	9.8 kg	9.8 kg	9.8 kg	9.8 kg	9.8 kg	9.8 kg
Malzeme(Gövde/Zemin)	PC-Kompozit Panel						

Elektronik Devre Teknik Özellikler

Solar Panel	Tip	Glass Laminated
	Ölçü (HxL)±%5	293x345 mm
	Voltaj	18 V
Jel Akü	Watt	10 W
	Malzeme	SLA
LED	Voltaj	12 V
	Akım	7.0 A/h
	Renk	Sarı Kırmızı-Beyaz
	Ölçü	Ø 5 mm
	Flaş Sayısı	54 f/dk
	Uyarı Mesafesi	500 m (gece)
	Çalışma Süresi	Gün ışığında şarj ile tüm gece
	Çalışma Sıcaklığı	-20°C/+60°C

Solar LED'li Trafik Levhaları



11846 FL

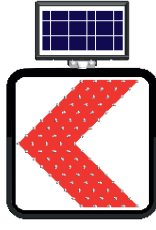

11834 FL



11842 FL



11800-32 FL

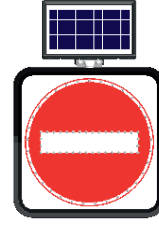

11800-37 FL



11849 FL

Ürün Teknik Özellikleri

Kod	11846 FL	11834 FL	11842 FL	11800-32 FL	11800-37 FL	11849 FL
Ölçü(HxL) ±%5	60x60cm	60x60cm	60x60cm	60x60cm	60x60cm	60x60cm
Ağırlık ±%5	9.8 kg	9.8 kg	9.8 kg	9.8 kg	9.8 kg	9.8 kg
Malzeme(Gövde/Zemin)	PC-Kompozit Panel					



11838 FL

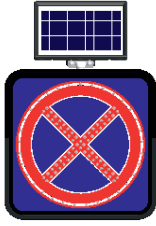

11840 FL



11839 FL



11841 FL

Ürün Teknik Özellikleri

- » hızlı şarj edebilme özelliğine sahip jel akü
- » tek yönde 54 f/dk flaşörlü uyarı
- » reflektif zemin ve gece uyarıcı LED'ler ve LED koruyucu Lensler.
- » solar enerji ile çalışan ve değişim gerektirmeyen batarya
- » gün ışığında şarj ile gün boyu sürekli, verimli ve etkin uyarı
- » solar panel, topuz şeklinde metal mafsal sayesinde kendi ekseninde 360°, öne-arkaya ve sağa-sola 45° yatabilme
- » açma-kapama düğmesi
- » koruma sınıfı IP 55
- » reflektif ASTM D 4956-11a Tip I
- » çalışma ortamı sıcaklığı -20°C/+60°C
- » omega direğe ve Ø5.0 ila Ø7.5 cm arası direğe montaj
- » geniş kullanım alanı: yollarda uyarı ve çalışma alanlarında, otoparklarda ve iş güvenliği gerektiren her türlü alanda

Ürün Teknik Özellikleri

Kod	11838 FL	11840 FL	11839 FL	11841 FL
Ölçü(HxL) ±%5	60x60cm	60x60cm	60x60cm	60x60cm
Ağırlık ±%5	9.8 kg	9.8 kg	9.8 kg	9.8 kg
Malzeme(Gövde/Zemin)	PC-Kompozit Panel			

AC / LED'li Yol Bakım Levhaları



11890 FL A



11886 FL A

11888 FL A (Sağ Yön)
11889 FL A (Sol Yön)11884 FL A
Sağ/Sol Yönde Uyarı

Ürün Teknik Özellikleri

Kod	11890 FL A	11886 FL A	11888 FL A	11889 FL A	11884 FL A
Ölçü(HxL) ±%5	60x60cm	60x60cm	60x60cm	60x60cm	60x60cm
Ağırlık ±%5	5.5 kg	5.5 kg	5.5 kg	5.5 kg	5.5 kg
Malzeme(Gövde/Zemin)	PC-Kompozit Panel				

Elektronik Devre Teknik Özellikler

Volтаж	12V AC	
	220 V AC	
LED	Renk	Sarı-Kırmızı-Beyaz
	Ölçü	Ø 5 mm
	Flaş Sayısı	54 f/dk
	Uyarı Mesafesi	500 m (gece)
Çalışma Sıcaklığı	-20°C/+60°C	

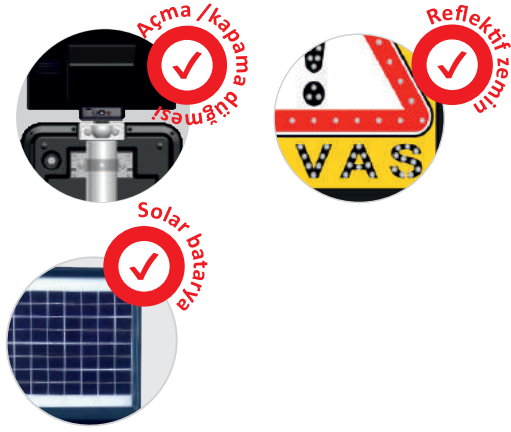

Levha Reflektif Özelliği

REFLEKTİF ASTM D 4956-11a Type I

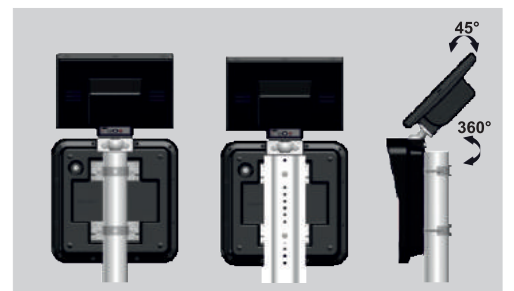

Solar LED'li Yol Bakım Levhaları



11730 S-LD



11764 S-LD

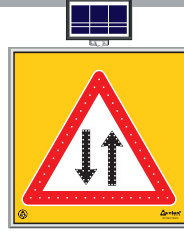

11762 S-LD

Ürün Teknik Özellikleri

Kod	11730 S-LD	11764 S-LD	11762 S-LD
Ölçü(HxL) ±%5	100x100cm	100x100cm	100x100cm
Ağırlık ±%5	16.5 kg	16.5 kg	16.5 kg
Malzeme(Gövde/Zemin)	AL-Kompozit Panel		

Elektronik Devre Teknik Özellikler

Solar Panel	Tip	Glass Laminated
	Ölçü (HxL)±%5	293x345 mm
	Voltaj	18 V
	Watt	10 W
	Malzeme	SLA
Jel Akü	Voltaj	12 V
	Akım	7.0 A/h
LED	Renk	Kırmızı-Beyaz
	Ölçü	Ø 5 mm
	Flaş Sayısı	54 f/dk
	Uyarı Mesafesi	500 m (gece)
	Çalışma Süresi	Gün ışığında şarj ile tüm gece
	Çalışma Sıcaklığı	-20°C/+60°C



11738 S-LD



11736 S-LD

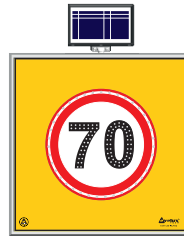

11734 S-LD

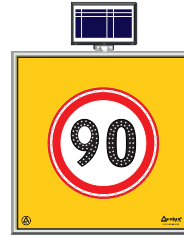

11732 S-LD

Ürün Teknik Özellikleri

Kod	11738 S-LD	11736 S-LD	11734 S-LD	11732 S-LD
Ölçü(HxL) ±%5	100x100cm	100x100cm	100x100cm	100x100cm
Ağırlık ±%5	16.5 kg	16.5 kg	16.5 kg	16.5 kg
Malzeme(Gövde/Zemin)	AL-Kompozit Panel			

Solar LED'li Yol Bakım Levhaları



11740 S-LD

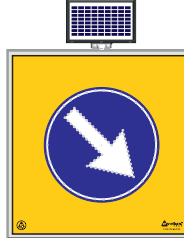

11742 S-LD

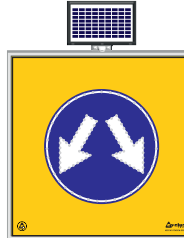

11744 S-LD

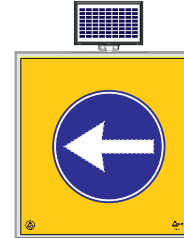

11746 S-LD

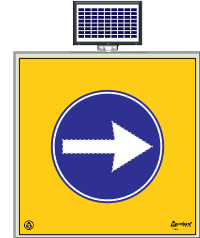

11748 S-LD

Ürün Teknik Özellikleri

Kod	11740 S-LD	11742 S-LD	11744 S-LD	11746 S-LD	11748 S-LD
Ölçü(HxL) ±%5	100x100cm	100x100cm	100x100cm	100x100cm	100x100cm
Ağırlık ±%5	16.5 kg	16.5 kg	16.5 kg	16.5 kg	16.5 kg
Malzeme(Gövde/Zemin)	AL-Kompozit Panel				



11766 S-LD

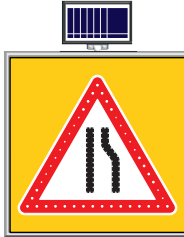

11775 S-LD



11776 S-LD

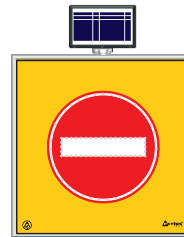

11768 S-LD

Ürün Teknik Özellikleri

Kod	11766 S-LD	11775 S-LD	11776 S-LD	11768 S-LD
Ölçü(HxL) ±%5	100x100cm	100x100cm	100x100cm	100x100cm
Ağırlık ±%5	16.5 kg	16.5 kg	16.5 kg	16.5 kg
Malzeme(Gövde/Zemin)	AL-Kompozit Panel			

Solar LED'li Yol Bakım Levhaları

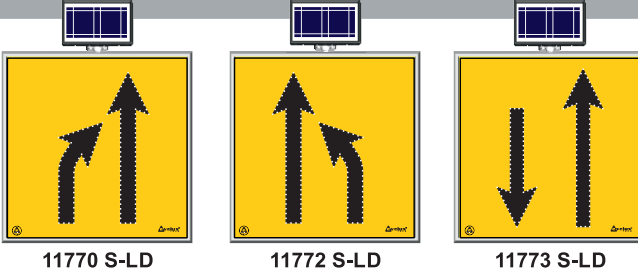

11770 S-LD

11772 S-LD

11773 S-LD

Ürün Teknik Özellikleri

Kod	11770 S-LD	11772 S-LD	11773 S-LD
Ölçü(HxL) ±%5	100x100cm	100x100cm	100x100cm
Ağırlık ±%5	16.5 kg	16.5 kg	16.5 kg
Malzeme(Gövde/Zemin)	AL-Kompozit Panel		

Ürün Teknik Özellikleri

- » hızlı şarj edebilme özelliğine sahip jel akü
- » tek yönde 54 f/dk flaşörlü uyarı
- » reflektif zemin ve gece uyarıcı LED'ler ve LED koruyucu Lensler
- » solar enerji ile çalışan ve değişim gerektirmeyen batarya
- » gün ışığında şarj ile günboyu sürekli, verimli ve etkin uyarı
- » solar panel, topuz şeklinde metal mafsal sayesinde kendi ekseninde 360°, öne-arkaya ve sağa-sola 45° yatabilme
- » açma-kapama düğmesi
- » çalışma ortamı sıcaklığı -20°C/+60°C
- » omega direğe ve Ø5.0 ila Ø7.5 cm arası direğe montaj
- » koruma sınıfı IP 54
- » reflektif ASTM D 4956-11a Tip I
- » geniş kullanım alanı: yollarda uyarı ve çalışma alanlarında, otoparklarda ve iş güvenliği gerektiren her türlü alanda

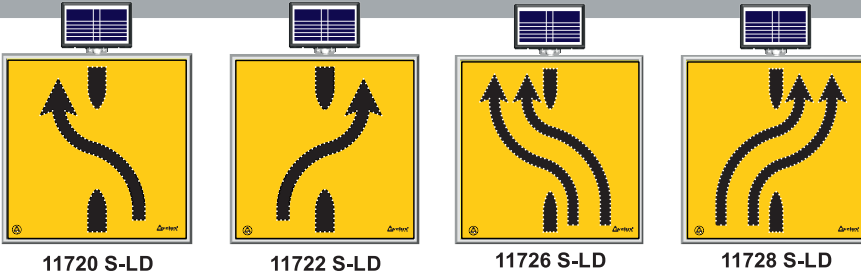

11720 S-LD

11722 S-LD

11726 S-LD

11728 S-LD

Ürün Teknik Özellikleri

Kod	11720 S-LD	11722 S-LD	11726 S-LD	11728 S-LD
Ölçü(HxL) ±%5	100x100cm	100x100cm	100x100cm	100x100cm
Ağırlık ±%5	16.5 kg	16.5 kg	16.5 kg	16.5 kg
Malzeme(Gövde/Zemin)	AL-Kompozit Panel			

Elektronik Devre Teknik Özellikler

Tip	Glass Laminated
Solar Panel	Ölçü (HxL)±%5 293x345 mm
	Voltaj 18 V
	Watt 10 W
	Malzeme SLA
Jel Akü	Voltaj 12 V
	Akım 7.0 A/h
	Renk Sarı
LED	Ölçü Ø 5 mm
	Flaş Sayısı 54 f/dk
	Uyarı Mesafesi 500 m (gece)
	Çalışma Süresi Gün ışığında şarj ile tüm gece
	Çalışma Sıcaklığı -20°C/+60°C

Solar LED'li Yol Bakım Levhaları

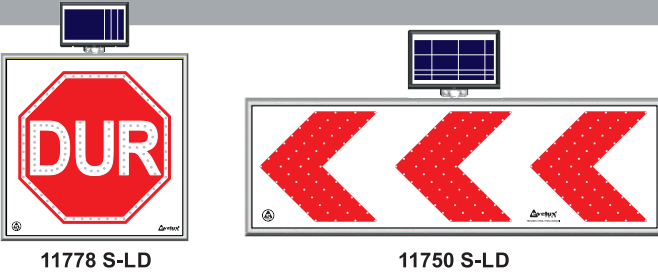

11778 S-LD

11750 S-LD

Ürün Teknik Özellikleri

Kod	11778 S-LD	11750 S-LD
Ölçü(HxL) ±%5	100x100cm	50x150cm
Ağırlık ±%5	16.5 kg	14.0 kg
Malzeme(Gövde/Zemin)	AL-Kompozit Panel	

Alüminyum Paslanmaz Gövde ve Paneller

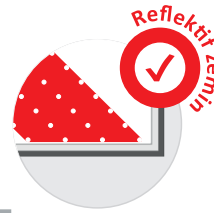

Levha Reflektif Özelliği

REFLEKTİF ASTM D 4956-11a Type I

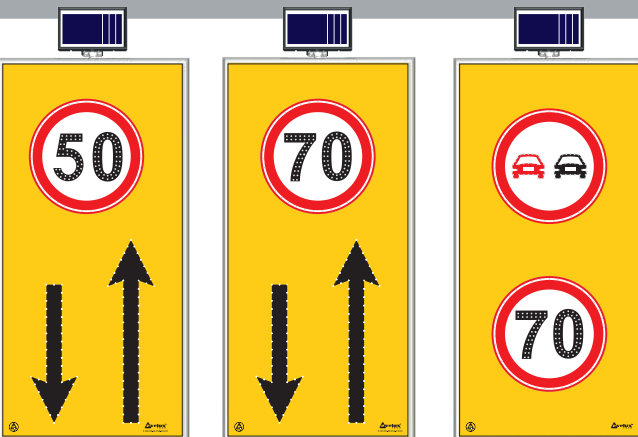

11710 S-LD

11712 S-LD

11716 S-LD

Ürün Teknik Özellikleri

Kod	11710 S-LD	11712 S-LD	11716 S-LD
Ölçü(HxL) ±%5	175x100cm	175x100cm	175x100cm
Ağırlık ±%5	25.0 kg	25.0 kg	25.0 kg
Malzeme(Gövde/Zemin)	AL-Kompozit Panel		

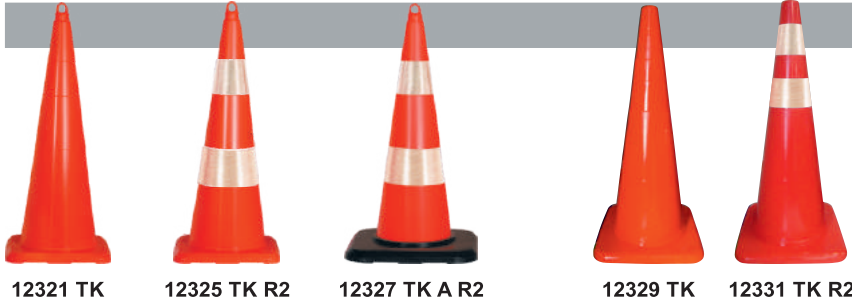

PVC Koniler (90 cm)

TSE BELGE / EN 13422+A1



Ürün Teknik Özellikler					
Kod	12321 TK	12325 TK R2	12327 TK A R2	12329 TK	12331 TK R2
Ölçü(AxH) ±%5 <input type="checkbox"/>	38.5x90cm	38.5x90cm	48.5x90cm	38.5x90cm	38.5x90cm
Ağırlık ±%5	3.6 kg	3.6 kg	6.9 kg	4.0 kg	4.0 kg
Malzeme	PVC	PVC	PVC	PVC	PVC



Ürün Teknik Özellikler						
Kod	12305 TK	12309 TK R2	12315 TK A R2	12326 TK A R1	12306 TK R1	12303 TK R1
Ölçü(AxH) ±%5 <input type="checkbox"/>	38.5x75cm	38.5x75cm	48.5x75cm	38.5x50cm	28.5x50cm	22x32cm
Ağırlık ±%5	3.2 kg	3.2 kg	6.5 kg	2.65 kg	1.3 kg	0.65 kg
Malzeme	PVC	PVC	PVC	PVC	PVC	PVC

PVC Koniler (70/50 cm)

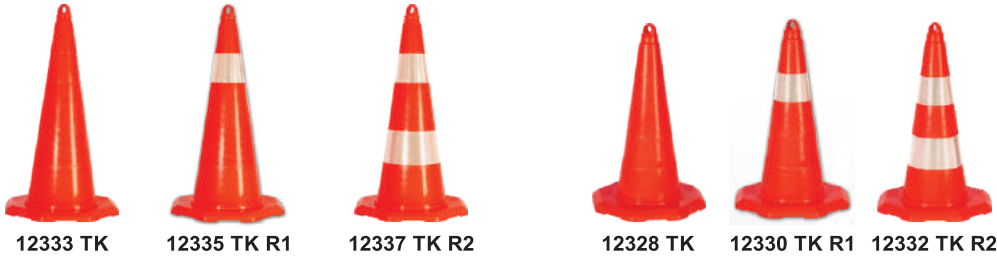

Ürün Teknik Özellikler						
Kod	12333 TK	12335 TK R1	12337 TK R2	12328 TK	12330 TK R1	12332 TK R2
Ölçü(AxH) ±%5 <input type="checkbox"/>	38x70cm	38x70cm	38x70cm	32x52cm	32x52cm	32x52cm
Ağırlık ±%5	2.3 kg	2.3 kg	2.3 kg	1.25 kg	1.25 kg	1.25 kg
Malzeme	PVC	PVC	PVC	PVC	PVC	PVC



PVC Koniler (60/50 cm)



Ürün Teknik Özellik						
Kod	12334 TK	12336 TK R2	12317 TK	12318 TK R1	12314 TK	12316 TK R2
Ölçü(AxH) ±%5 <input type="checkbox"/>	37x60cm	37x60cm	35x50cm	35x50cm	35x50cm	35x50cm
Ağırlık ±%5	1.8 kg	1.8 kg	1.8 kg	1.8 kg	1.7 kg	1.7 kg
Malzeme	PVC	PVC	PVC	PVC	PVC	PVC



TPE Koniler (90 cm)

TPE Koniler (75 cm)

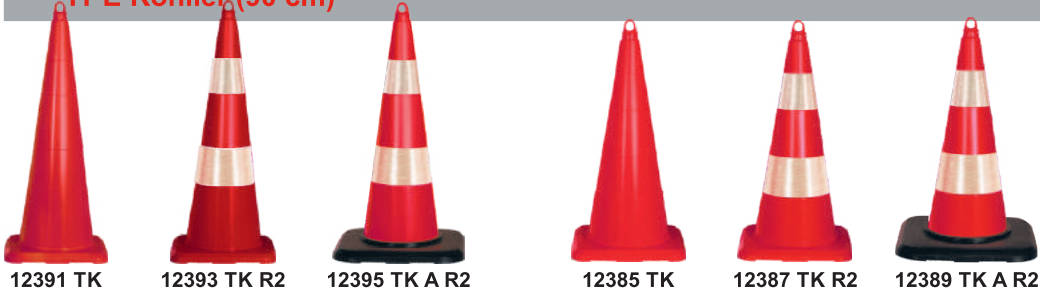

12391 TK 12393 TK R2 12395 TK A R2 12385 TK 12387 TK R2 12389 TK A R2

Ürün Teknik Özellikler

Kod	12391 TK	12393 TK R2	12395 TK A R2	12385 TK	12387 TK R2	12389 TK A R2
Ölçü(AxH) ±%5 <input type="checkbox"/>	38.5x90cm	38.5x90cm	48.5x90cm	38.5x75cm	38.5x75cm	48.5x75cm
Ağırlık ±%5	3.0 kg	3.0 kg	6.3 kg	2.7 kg	2.7 kg	6.0 kg
Malzeme	TPE	TPE	TPE	TPE	TPE	TPE

TPE Koniler (70/50 cm)



%100 TPE ESNEK KIRILMAZ



12372 TK 12374 TK R1 12376 TK R2 12366 TK 12368 TK R1 12370 TK R2

Ürün Teknik Özellikler

Kod	12372 TK	12374 TK R1	12376 TK R2	12366 TK	12368 TK R1	12370 TK R2
Ölçü(AxH) ±%5 <input type="checkbox"/>	38x70cm	38x70cm	38x70cm	32x52cm	32x52cm	32x52cm
Ağırlık ±%5	1.9 kg	1.9 kg	1.9 kg	1.0 kg	1.0 kg	1.0 kg
Malzeme	TPE	TPE	TPE	TPE	TPE	TPE

Klasik Kedi Gözülü / Ultra Kedi Gözülü / Eko Trafik Konileri



12300 TK 12301 TK A 12350 TK 12351 TK A 12352 TK A 12302 TK 12320 TK A R2 12322 TK R2

Ürün Teknik Özellikleri

Kod	12300 TK	12301 TK A	12350 TK	12351 TK A	12352 TK A	12302 TK	12320 TK A R2	12322 TK R2
Ölçü(AxH) ±%5 <input type="checkbox"/>	35x50cm	35x52cm	37x60cm	37x61.3cm	37x61.3cm	35x50cm	46x75cm	40x75cm
Ağırlık ±%5	1.2 kg	4.0 kg	1.4 kg	5.0 kg	5.0 kg	0.90 kg	4.9 kg	2.2 kg
Malzeme(Gövde/Taban)	PPC	PPC-PVC	PPC	PPC-PVC	PPC-PVC	PPC	PPC-PVC	PPC

Reklam Dubaları ve Levhaları

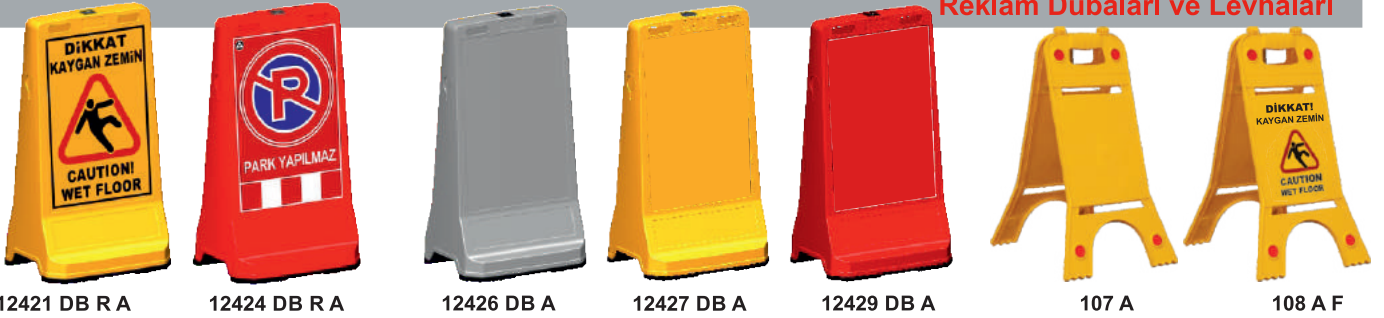

12421 DB R A 12424 DB R A 12426 DB A 12427 DB A 12429 DB A 107 A 108 A F

Ultra Levhali Reklam Dubaları

- » Kolay taşınabilir pratik gövde
- » Yan yüzeylerde zincir geçirme kanalı
- » Ağırlıklı taban ile devrilmeye karşı güçlü mukavemet
- » Yıvli, lamba / levha takma yuvası
- » Lamba ve levha takılabilme özelliği ile daha etkin uyarı
- » İki yönde uyarı

Ürün Teknik Özellikleri

Kod	12421 DB R A	12424 DB R A	12426 DB A	12427 DB A	12429 DB A	107 A	108 A F
Ölçü(HxLxW) ±%5 (cm)	90x49.5x39.5	90x49.5x39.5	90x49.5x39.5	90x49.5x39.5	90x49.5x39.5	(HxL)62x24.5	(HxL)62x24.5
Etiket (HxL) ±%5	60x40 cm	60x40 cm	-	-	-	-	27x20 cm
Ağırlık ±%5	7.5 kg	7.5 kg	7.5 kg	7.5 kg	7.5 kg	1.0 kg	1.0 kg
Malzeme(Gövde/Taban)	PPC-PVC	PPC-PVC	PPC-PVC	PPC-PVC	PPC-PVC	ABS	ABS

Esnek Refüj Başı Levhaları

Ürün Teknik Özellikleri

Kod	12253 UB R	12254 UB R	12250 UB R
Ölçü(HxØ) ±%5	75x12cm	90x22cm	100x32cm
Levha(HxL) ±%5	40x10cm	54x20cm	64x30cm
Taban(LxW) ±%5	Ø 20cm	20x15cm	26x20cm
Ağırlık ±%5	1.4 kg	2.0 kg	3.25 kg
Malzeme	TPU	TPU	TPU
Montaj	4 Adet Özel Flanşlı Trifon Vida ve Dübel (10x100 mm)		

TSE BELGE / EN 13422+A1



REFLEKTİF TS EN 13422+A1



Şerit Ayırıcı Esnek Delinatörler

Ürün Teknik Özellikleri

Kod	(Black)	12282 UB R	12284 UB R	12286 UB R	12288 UB R
Kod	(Yellow)	12245 UB R	12244 UB R	12242 UB R	12241 UB R
Ölçü(HxØ) ±%5		30x8.0cm	45x8.0cm	75x8.0cm	100x8.0cm
Taban(Ø) ±%5		20cm	20cm	20cm	20cm
Ağırlık ±%5		0.72 kg	0.98 kg	1.3 kg	1.6 kg
Malzeme		TPU	TPU	TPU	TPU
Montaj		3 Adet Özel Flanşlı Trifon Vida ve Dübel (10x100 mm)			

TSE BELGE / EN 13422+A1

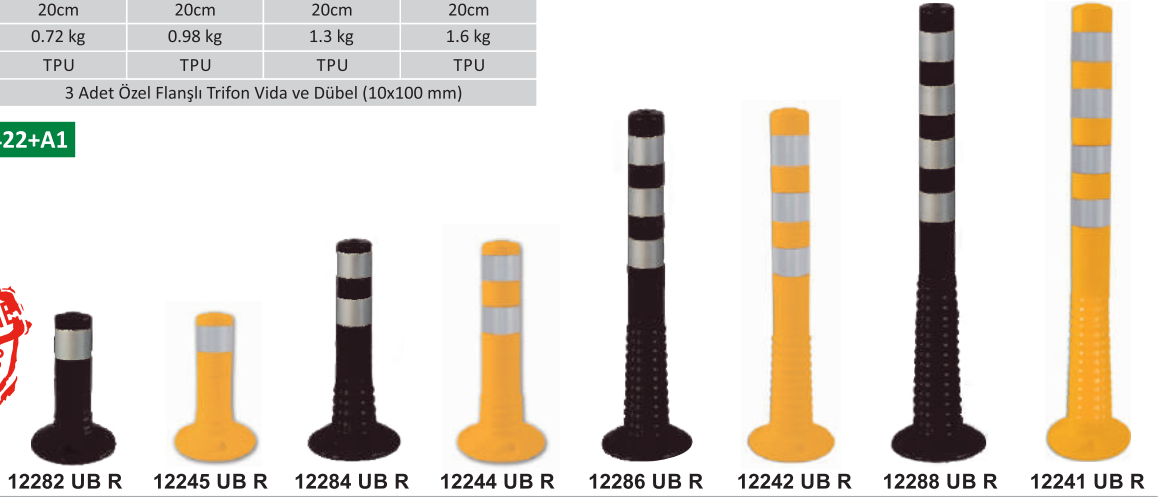

Şerit Ayırıcı Esnek Delinatörler

Ürün Teknik Özellikleri

Kod	12225 UB R	12224 UB R	12222 UB R	12221 UB R
Ölçü(HxØ) ±%5	30x8.0cm	45x8.0cm	75x8.0cm	100x8.0cm
Taban(Ø) ±%5	20cm	20cm	20cm	20cm
Ağırlık ±%5	0.72 kg	0.98 kg	1.3 kg	1.6 kg
Malzeme	TPU	TPU	TPU	TPU
Montaj	3 Adet Özel Flanşlı Trifon Vida ve Dübel (10x100 mm)			

TSE BELGE / EN 13422+A1



Otopark Düzenleyici Esnek Delinatörler

Ürün Teknik Özellikleri

Kod	12274 UB R	12272 UB R	12275 UB R 22019 UB R	12273 UB R 22018 UB R	12271 UB R 22017 UB R	12269 UB R 22016 UB R
Ölçü(HxØ) ±%5	40x8.0cm	70x8.0cm	30x8.0cm	45x8.0cm	75x8.0cm	100x8.0cm
Taban(Ø) ±%5	18cm	18cm	20cm	20cm	20cm	20cm
Ağırlık ±%5	0.52 kg	0.74 kg	0.54 kg	0.73 kg	0.95 kg	1.2 kg
Malzeme	TPE	TPE	TPE	TPE	TPE	TPE
Montaj	3 Adet Özel Flanşlı Trifon Vida ve Dübel (10x100 mm)					

REFLEKTİF TS EN 13422+A1



Şerit Ayırıcı Esnek Delinatörler

Ürün Teknik Özellikleri

Kod	12215 UB R	12214 UB R	12212 UB R	12211 UB R
Ölçü(HxØ) ±%5	30x8.0cm	45x8.0cm	75x8.0cm	100x8.0cm
Taban(Ø) ±%5	20cm	20cm	20cm	20cm
Ağırlık ±%5	0.72 kg	0.98 kg	1.3 kg	1.6 kg
Malzeme	TPU	TPU	TPU	TPU
Montaj	3 Adet Özel Flanşlı Trifon Vida ve Dübel (10x100 mm)			

TSE BELGE / EN 13422+A1

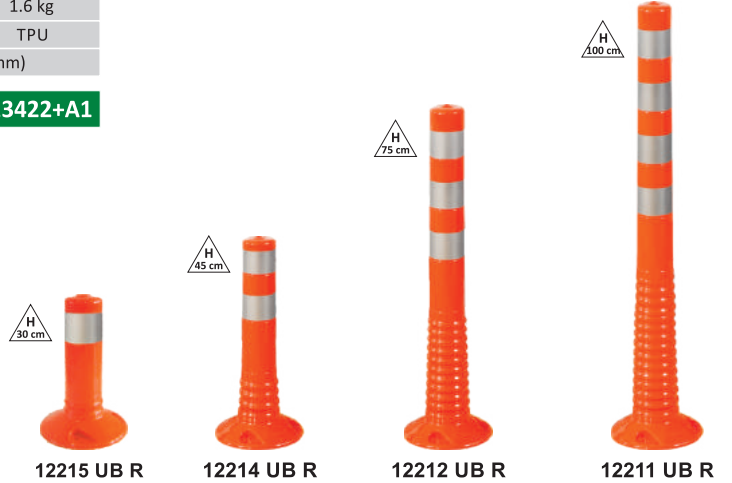

Şerit Ayırıcı Esnek Delinatörler (Soketli)

Ürün Teknik Özellikleri

Kod	12283 UB R	12281 UB R	12237 UB R	12247 UB R	12243 UB R	12249 UB R
Ölçü(HxØ) ±%5	40x8.0cm	70x8.0cm	75x11cm	50x8.0cm	75x9.0cm	100x10cm
Taban(Ø) ±%5	18cm	18cm	26cm	20cm	20cm	20cm
Ağırlık ±%5	0.70 kg	1.0 kg	2.1 kg	1.0 kg	1.5 kg	2.0 kg
Malzeme	TPU	TPU	TPU	TPU	TPU	TPU
Montaj	3 Adet		4 Adet		3 Adet	
	Özel Flanşlı Trifon Vida ve Dübel (10x100 mm)					

TSE BELGE / EN 13422+A1

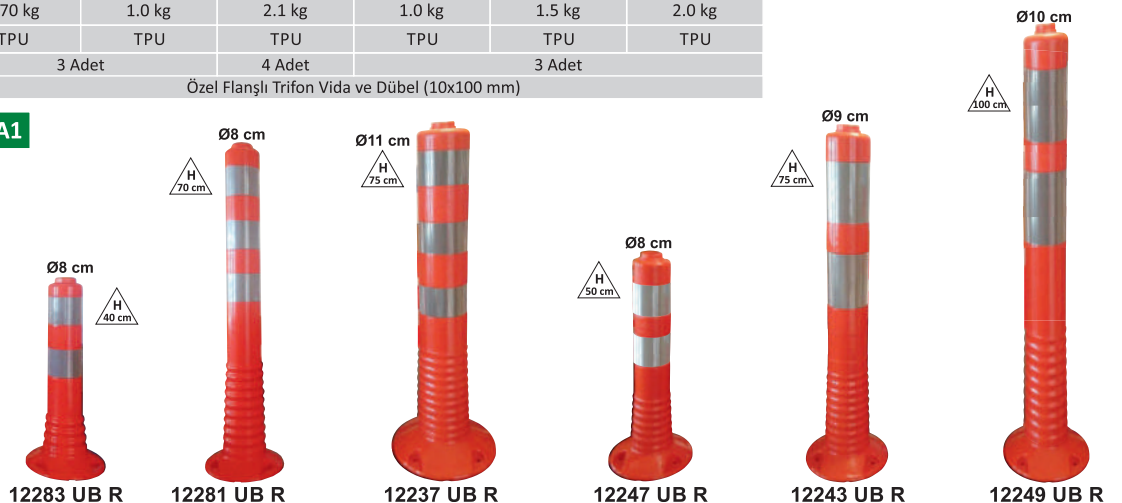

92 93 96 97 98 100 101 102

Demonte Delinatörler

TSE BELGE / EN 13422+A1

BETON /ASFALT ZEMİNE UYGULAMA

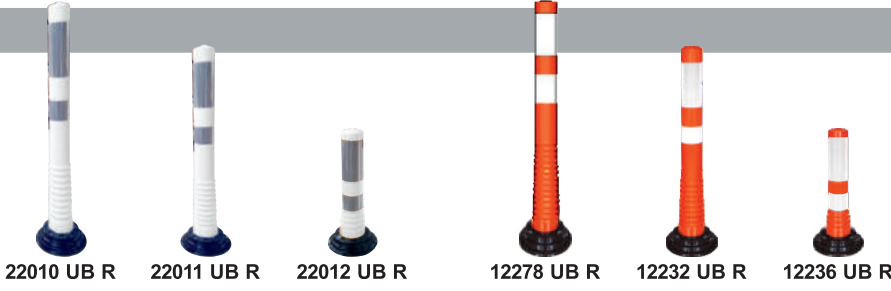

Epoksi yapıştırıcı ile zemine uygulama.

Özel Flaşlı Trifon Vida ve Dübel (10x100 mm)

Ürün Teknik Özellikleri

Kod	22010 UB R	22011 UB R	22012 UB R	12278 UB R	12232 UB R	12236 UB R
Ölçü(HxØ) ±%5	92x8.0cm	75x8.0cm	45x8.0cm	92x8.0cm	75x8.0cm	45x8.0cm
Taban(Ø) ±%5	20cm	20cm	20cm	20cm	20cm	20cm
Ağırlık ±%5	1.65 kg	1.48 kg	1.1 kg	1.65kg	1.48 kg	1.1 kg
Malzeme	TPU-ABS	TPU-ABS	TPU-ABS	TPU-ABS	TPU-ABS	TPU-ABS
Montaj	EPOKSİ					

Delinatörlü ve Levhalı Şerit Düzenleme Butonları

Montaj:
12270 UB R / 12268 UB R / 12251 UB R
6 Adet / Özel Flaşlı Trifon Vida ve Dübel (10x100 mm)



Montaj:
12218 UB R / 12219 UB R / 12297 UB R
4 Adet / Özel Flaşlı Trifon Vida ve Dübel (10x100 mm)



Montaj: 12266 UB R
6 Adet / Özel Flaşlı Trifon Vida ve Dübel(10x100 mm)



Ürün Teknik Özellikleri

Kod	12270 UB R	12268 UB R	12251 UB R	12218 UB R	12219 UB R	12297 UB R	12266 UB R
Ölçü(HxLxW) ±%5	7.5x100x22cm	7.5x100x22cm	7.5x100x22cm	8.0x100x20cm	8.0x100x20cm	8.0x100x22cm	7.5x100x22cm
Delinatör(HxØ) ±%5	38x8.0cm	68x8.0cm	82.5x8.0cm	37.5x8.0cm	67.5x8.0cm	82x8.0cm	57.5x13cm
Ağırlık ±%5	3.8 kg	4.2 kg	4.6 kg	4.1 kg	4.5 kg	4.8 kg	3.6 kg
Malzeme(delinatör/gövde)	TPU-PPC	TPU-PPC	TPU-PPC	TPU-PPC	TPU-PPC	TPU-PPC	PPC-PPC

Levhalı Şerit Düzenleme Butonları

Montaj:
12203 UB R / 12204 UB R
3 Adet / Özel Flaşlı Trifon Vida ve Dübel (10x100 mm)

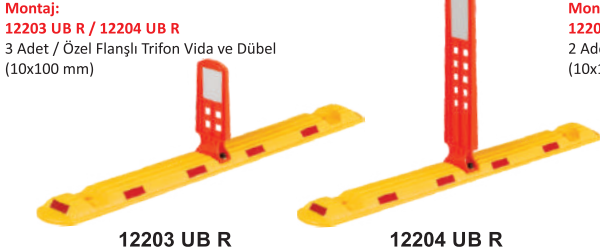

Montaj:
12207 UB R / 12206 UB R
2 Adet / Özel Flaşlı Trifon Vida ve Dübel (10x100 mm)



Levhalı Esnek Delinatörler

Montaj:
12258 UB R / 12256 UB R
4 Adet / Özel Flaşlı Trifon Vida ve Dübel (10x100 mm)



Ürün Teknik Özellikleri

Kod	12203 UB R	12204 UB R	12207 UB R	12206 UB R	12258 UB R	12256 UB R
Ölçü(HxLxW) ±%5	4.8x120x15cm	4.8x120x15cm	4.5x26x16cm	4.5x26x16cm	(HxL)45x12cm	(HxL)75x12cm
Levha(HxL) ±%5	25x11cm	55x12cm	25x11cm	55x12cm	20cm	20cm
Ağırlık ±%5	2.5 kg	2.7 kg	0.75 kg	0.90 kg	0.95 kg	1.4 kg
Malzeme(levha/gövde)	TPU-PPC	TPU-PPC	TPU-PPC	TPU-PPC	TPU	TPU

TSE BELGE / EN 13422+A1



Şerit Sınırlama Butonları

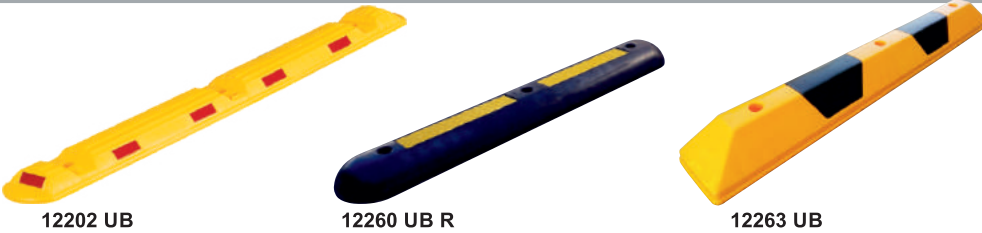

Ürün Teknik Özellikleri

Kod	12202 UB	12260 UB R	12263 UB	12261 UB
Ölçü(HxLxW) ±%5	4.8x120x15cm	6.0x100x15cm	10x110x15cm	10x55x15cm
Ağırlık ±%5	2.3 kg	6.0 kg	4.2 kg	1.9 kg
Malzeme	PPC	PVC	PPC	PPC
Montaj	3 Adet		2 Adet	
	Özel Flaşlı Trifon Vida ve Dübel (10x100 mm)			



Şerit Sınırlama Butonları



12262 UB

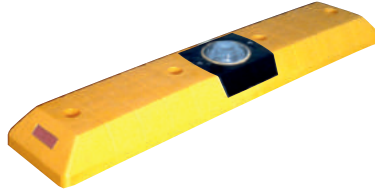

12217 UB

12220 UB
(Solar Flaşörlü)

Ürün Teknik Özellikleri

Kod	12262 UB	12217 UB	12220 UB
Ölçü (HxLxW) ±%5	9.0x100x22cm	8.0x100x20cm	8.0x100x20cm
Ağırlık ±%5	3.5 kg	4.1 kg	3.7 kg
Malzeme	PPC	PPC	PPC
Montaj	6 Adet	4 Adet	
	Özel Flaşlı Trifon Vida ve Dübel (10x100 mm)		

Elektronik Devre Teknik Özellikler

Solar Panel	Tip	monocrystalline silikon cell
	Ölçü (HxL)±%5	60x54 mm
	Voltaj	3 V
Şarjlı Pil	Watt	0.4 W
	Malzeme	Ni-MH
LED	Voltaj	1.2 V
	Akım	2000 mA/h
	Renk	Sarı-Kırmızı
	Ölçü	(Ø 5 mm)
	Flaş Sayısı	115 f/dk
	F.Uyarı Mesafesi	100 m (gece)
	Çalışma Süresi	Gün ışığında şarj ile tüm gece
	Çalışma Sıcaklığı	-20°C/+60°C

Solar Yol İşaretleme Butonları

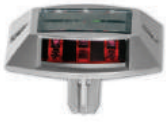

11924 SL K

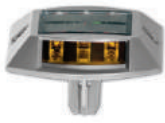

11926 SL S



11920 SL K



11922 SL S



11921 SL K



11923 SL S

Ürün Teknik Özellikleri

Kod	11924 SL K	11926 SL S	11920 SL K	11922 SL S	11921 SL K	11923 SL S
Ölçü (HxLxW) ±%5	2.8x12.5x14.5cm	2.8x12.5x14.5cm	2.8x12.5x14.5cm	2.8x12.5x14.5cm	2.8x12x13.5cm	2.8x12x13.5cm
Ağırlık ±%5	0.48 kg	0.48 kg	0.45 kg	0.45 kg	0.57 kg	0.57 kg
Malzeme	AL	AL	AL	AL	AL	AL
Montaj	Ø3.0x(H)5.0 cm Ankara Saplanır		2 Adet Buldex Vida ve Dübel (7.5x80 mm)			

Cam Kedi Gözlü Yol Butonları



12011 YB



12007 YB



12009 YB



12005-2 YB



12005-3 YB

Ürün Teknik Özellikleri

Kod	12011 YB	12007 YB	12009 YB	12005-2 YB	12005-3 YB
Ölçü (HxLxW) ±%5	2.1x10x10cm	2.8x12x12cm	2.1x10x10cm	2.1x10x10cm	2.1x10x10cm
Ağırlık ±%5	0.40 kg	0.30 kg	0.15 kg	0.15 kg	0.15 kg
Malzeme	AL	AL	ABS	ABS	ABS
Montaj	Ø2.0x(H)5.0 cm Epoksi Yapıştırıcı İle	2 Adet Buldex Vida ve Dübel (7.5x100 mm)	2 Adet Buldex Vida ve Dübel (7.5x80 mm)		



Mercekli Yol Butonları



12005 YB



12004 YB



12006 YB

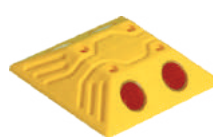

12000 YB



12002 YB



12003 YB

Ürün Teknik Özellikleri

Kod	12005 YB	12004 YB	12006 YB	12000 YB	12002 YB	12003 YB
Ölçü (HxLxW) ±%5	2.0x10.5x10.5cm	2.5x14x12cm	2.8x22x12cm	3.2x15x12.5cm	2.8x12x12cm	3.2x22x10cm
Ağırlık ±%5	0.12 kg	0.12 kg	0.22 kg	0.20 kg	0.18 kg	0.24 kg
Malzeme	ABS	PPC	PPC	PPC	PPC	PPC
Montaj	2 Adet Buldex Vida ve Dübel (7.5x80 mm)	4 Adet Burgulu Çivi (5.5x105 mm)	2 Adet Buldex Vida ve Dübel (7.5x100 mm)	4 Adet Burgulu Çivi (5.5x105 mm)		

Kauçuk Şaseli Yol Kasileri

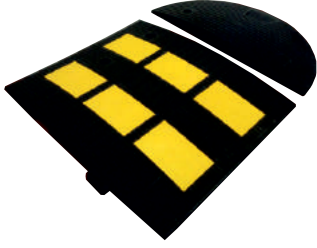

12116 YK - 12109 YK K



12108 YK - 12109 YK K



12110 YK - 12111 YK K

Ürün Teknik Özellikleri

Kod	12116 YK	12109 YK K	12108 YK	12109 YK K	12110 YK	12111 YK K
Ölçü(HxLxW) ±%5	4.5x60x50cm	4.5x60x30cm	4.5x60x50cm	4.5x60x30cm	4.0x40x50cm	4.0x40x20cm
Ağırlık ±%5	9.3 kg	3.4 kg	9.3 kg	3.4 kg	6.5 kg	1.7 kg
Malzeme	PVC Compound	PVC Compound	PVC Compound	PVC Compound	PVC Compound	PVC Compound
Montaj	6 Adet	2 Adet	4 Adet	2 Adet	4 Adet	2 Adet
Özel Flanşlı Trifon Vida ve Dübel (10x100 mm)						

Reflektif Bant Özellikleri

Minimum Yansım Değerleri	
Renk	Sarı
Giriş Açısı	88,76°
Gözlem Açısı	1,05°
Geriyansım (mcd/lx.m²)	500

Kauçuk Şaseli Yol Kasileri



12106 YK - 12107 YK K



12104 YK - 12105 YK K



Ürün Teknik Özellikleri

Kod	12106 YK	12107 YK K	12104 YK	12105 YK K
Ölçü(HxLxW) ±%5	4.0x40x50cm	4.0x40x20cm	4.5x50x33cm	4.5x50x25cm
Ağırlık ±%5	6.5 kg	1.7 kg	6.2 kg	3.0 kg
Malzeme	PVC Compound	PVC Compound	PVC Compound	PVC Compound
Montaj	4 Adet	2 Adet	4 Adet	2 Adet
Özel Flanşlı Trifon Vida ve Dübel (10x100 mm)				



Sarı/Siyah Renk Seçeneği

PPC Yol Kasileri

12112 YK - 12113 YK K
Kedi Gözülü Yol Kasisi12100 YK - 12101 YK K
Klasik Yol Kasisi12102 YK - 12103 YK K
Oval Yol Kasisi11938 SL - 11940 SL K
Solar Flaşörlü Yol Kasisi

Renk

Ürün Teknik Özellikleri

Kod	12112 YK	12113 YK K	12100 YK	12101 YK K	12102 YK	12103 YK K	11938 SL	11940 SL K
Ölçü(HxLxW) ±%5	4.5x50x50	4.5x50x25	5.0x25x34.5	5.0x25x10	4.0x30x33.5	4.0x30x10	4.5x50x50	4.5x50x25
Ağırlık ±%5	3.1 kg	1.1 kg	1.5 kg	0.35 kg	1.35 kg	0.25 kg	3.1 kg	1.1 kg
Malzeme	PPC	PPC	PPC	PPC	PPC	PPC	PPC	PPC
Montaj	4 Adet	2 Adet	4 Adet	2 Adet	4 Adet	2 Adet	4 Adet	2 Adet
Özel Flanşlı Trifon Vida ve Dübel (10x100 mm)								

11938 SL - Hız Kesici Kası

Elektronik Devre Teknik Özellikleri

Solar Panel	Tip	monocrystalline silicon cell
Ölçü(HxL)±%5	54x60 mm	
Voltaj	3 V	
Watt	0.4 W	
Malzeme	Ni-MH	
Şarjlı Pil	Voltaj	1.2 V
Akım	2000 mA/h	
LED	Renk	Sarı-Kırmızı
Ölçü	(Ø5 mm)	
Flaş Sayısı	120 f/dk	
Uyarı Mesafesi	300 m (gece)	
Çalışma Süresi	Gün ışığında şarj ile tüm gece	
Çalışma Sıcaklığı	-20°C/+60°C	

Araç Stoperleri

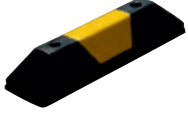
12235 UB
(55 cm)12233 UB
(110 cm)12231 UB
(180 cm)12216 UB R
(10x50x16 cm)

Ürün Teknik Özellikleri

Kod	12235 UB	12233 UB	12231 UB	12216 UB R
Ölçü(HxLxW) ±%5	10x55x15cm	10x110x15cm	10x180x15cm	10x50x16cm
Ağırlık ±%5	1.9 kg	4.3 kg	6.8 kg	2.4 kg
Malzeme	PPC	PPC	PPC	PVC
Montaj	2 Adet	3 Adet	5 Adet	3 Adet
Özel Flaşlı Trifon Vida ve Dübel (10x100 mm)				



Otopark Kasis Kapanı



12290 UB

12291 UB K



Ürün Teknik Özellikleri

Kod	12290 UB	12291 UB K
Ölçü(HxLxW) ±%5	6.0x50x50cm	6.0x50x9.0cm
Ağırlık ±%5	7.3 kg	0.70 kg
Malzeme	Metal-PPC	PPC
Montaj	6 Adet	2 Adet
Özel Flaşlı Trifon Vida ve Dübel (10x100 mm)		

Kablo ve Hortum Koruyucu Kasis ve Köşesi



12299 UB



12298 UB

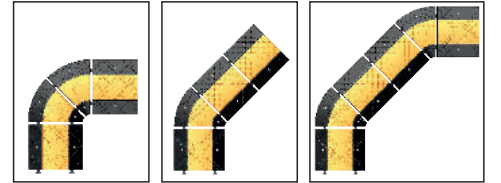

Ürün Teknik Özellikleri

Kod	12299 UB	12298 UB
Ölçü(HxLxW) ±%5	7.5x60x50cm	7.5x60x50cm
Ağırlık ±%5	3.0 kg	8.7 kg
Malzeme	PPC	PPC
Montaj	2 Adet Özel Flaşlı Trifon Vida ve Dübel (10x100 mm)	

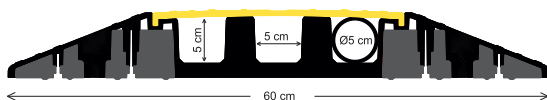

Otopark Kolon Köşe Koruyucular



12296 UB R 12294 UB R 12295 UB R 12292 UB R

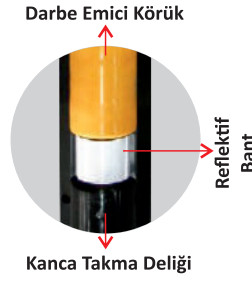

Reflektif Yansıtıcı Yüzeyler / Yüksek Görünürlük



Ürün Teknik Özellikleri

Kod	12296 UB R	12294 UB R	12295 UB R	12292 UB R
Ölçü(HxL) ±%5	80x8.0cm	80x8.0cm	80x9.0cm	90x10cm
Ağırlık ±%5	1.9 kg	1.9 kg	2.0 kg	1.9 kg
Malzeme	PVC	PVC	PVC	PVC-PE
Montaj	6 Adet Özel Plastik Vida ve Dübel (8x30 mm)			

Trafik Güvenlik Aynaları

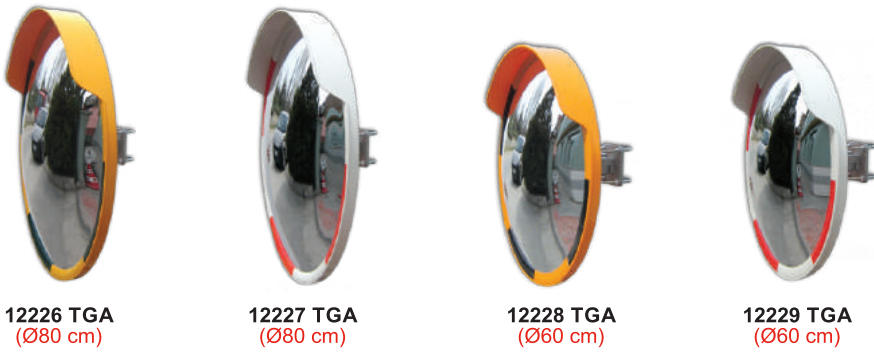
12226 TGA
(Ø80 cm)12227 TGA
(Ø80 cm)12228 TGA
(Ø60 cm)12229 TGA
(Ø60 cm)

Ürün Teknik Özellikleri

Kod	12226 TGA	12227 TGA	12228 TGA	12229 TGA
Ölçü (Ø) ±%5	Ø80cm	Ø80cm	Ø60cm	Ø60cm
Ağırlık ±%5	6.0 kg	6.0 kg	4.0 kg	4.0 kg
Malzeme(gövde-ayna)	PPC-Akrilik	PPC-Akrilik	PPC-Akrilik	PPC-Akrilik

Trafik Güvenlik Aynaları

12248 TGA
(60x80 cm)12246 TGA
(60x80 cm)12267 TGA
(40x60 cm)12265 TGA
(40x60 cm)

Ürün Teknik Özellikleri

Kod	12248 TGA	12246 TGA	12267 TGA	12265 TGA
Ölçü (HxL) ±%5	60x80cm	60x80cm	40x60cm	40x60cm
Ağırlık ±%5	5.6 kg	5.6 kg	3.6 kg	3.6 kg
Malzeme(gövde-ayna)	ABS-Akrilik	ABS-Akrilik	ABS-Akrilik	ABS-Akrilik

Ayna (Akrilik LENS) Teknik Özellikleri

Görüş Mesafesi	12 m / 16 m
Görüş Açısı	>150°
Darbe Dayanımı	15 kJ/m ²
Malzeme	Acrylic
TEST STANDARDI	ISO 179/1fu

Refüj Dubaları



12213 UB R



22035 UB R



12223 UB R



22031 UB R



12205 UB R



22033 UB R

Ürün Teknik Özellikleri

Kod	12213 UB R	22035 UB R	12223 UB R	22031 UB R	12205 UB R	22033 UB R
Ölçü ±%5	(HxØ)80x9.0cm	(HxØ)80x9.0cm	(HxØ)50x9.0cm	(HxØ)50x9.0cm	(H)50cm	(H)50cm
Taban	Ø20cm	Ø20cm	Ø20cm	Ø20cm	25cm	25cm
Ağırlık ±%5	1.25 kg	1.25 kg	0.90 kg	0.90 kg	1.5 kg	1.5 kg
Malzeme	PPC	PPC	PPC	PPC	PE	PE
Montaj	4 Adet Özel Flanşlı Trifon Vida ve Dübel (10x100 mm)					



Demonte Refüj Dubaları



12276 UB D



12277 UB D



12279 UB D

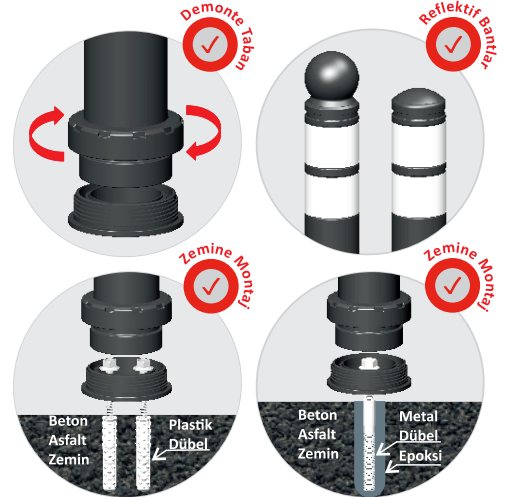

12280 UB D

188 A
Refüj Duba Anahtarı

Ürün Teknik Özellikleri

Kod	12276 UB D	12277 UB D	12279 UB D	12280 UB D	188 A
Ölçü ±%5	(HxØ)87x8.0cm	(HxØ)68x8.0cm	(HxØ)81.5x8.0cm	(HxØ)62.5x8.0cm	Ø11 cm
Taban	Ø11cm	Ø11cm	Ø11cm	Ø11cm	-
Ağırlık ±%5	1.72 kg	1.38 kg	1.62 kg	1.28 kg	0.17 kg
Malzeme	TPU-PA	TPU-PA	TPU-PA	TPU-PA	Metal
Montaj	2 Adet Özel Flanşlı Trifon Vida ve Dübel (10x100 mm)				

Alternatif Uygulama Seçeneği

Dış Yüzeyler UV Dayanımlı Boyalıdır.



12289 UB ST

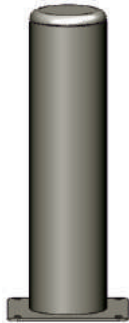

12293 UB ST



12287 UB ST



12285 UB PU

Uyarı: Flanşlı metal dubalar zemine uygun dübel seçimi yapılarak uygulanmalıdır.

Ürün Teknik Özellikleri

Kod	12289 UB ST	12293 UB ST	12287 UB ST	12285 UB PU
Ölçü ±%5	(HxØ) 78x15 cm	(HxØ) 61x15 cm	(HxØ) 78x15 cm	(HxØ) 78x15 cm
Taban	(LxW)24x24 cm	(LxW)24x24 cm	Ø15x18 cm	Ø17x18 cm
Ağırlık ±%5	9.0 kg	7.4 kg	7.3 kg	3.3 kg
Malzeme	Metal	Metal	Metal	PU
Montaj	4 Adet Özel Flanşlı Trifon Vida ve Dübel (10x100 mm)		Beton Harç İle	

Anti-Park Dubaları

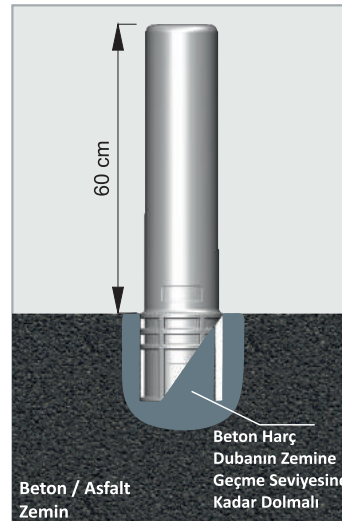
12285 UB PU-12287 UB ST
Zemin Uygulaması (Beton Harç)12285 UB PU
PU Anti-Park Duba
Test UygulamaBeton / Asfalt
ZeminBeton Harç
Dubanın Zemine
Geçme Seviyesine
Kadar Dolmalı

Görme Engelli Zemin İşaretlemeleri

Uyarı Yüzeyi

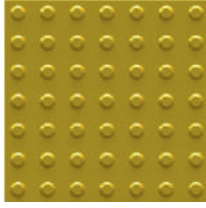

PL 8010

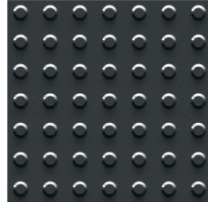

PL 8011

Takip Yüzeyi

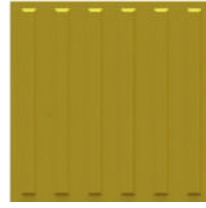

PL 8012



PL 8013

Ürün Teknik Özellikleri

Kod	PL 8010	PL 8011	PL 8012	PL 8013
Ölçü(HxLxW) ±%5	0.8x40x40 cm	0.8x40x40 cm	0.8x40x40 cm	0.8x40x40 cm
Ağırlık ±%5	0.70 kg	0.70 kg	0.85 kg	0.85 kg
Malzeme	TPU	TPU	TPU	TPU
Montaj	EPOKSİ			



Görme Engelli Zemin İşaretlemeleri

Uyarı Yüzeyi

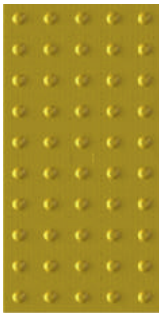

PL 8014



PL 8015

Takip Yüzeyi



PL 8016



PL 8017

Ürün Teknik Özellikleri

Kod	PL 8014	PL 8015	PL 8016	PL 8017
Ölçü(HxLxW) ±%5	0.8x30x60 cm	0.8x30x60 cm	0.8x30x60 cm	0.8x30x60 cm
Ağırlık ±%5	0.77 kg	0.77 kg	0.90 kg	0.90 kg
Malzeme	TPU	TPU	TPU	TPU
Montaj	EPOKSİ			



Görme Engelli Zemin İşaretlemeleri

Uyarı Yüzeyi

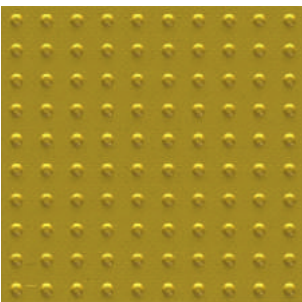

PL 8018

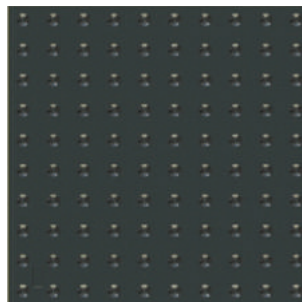

PL 8019

Uyarı ve Takip Yüzeyi Uygulama Seçeneği

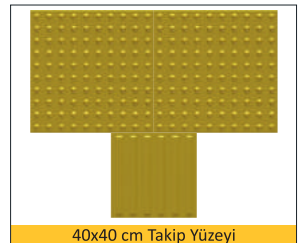

40x40 cm Takip Yüzeyi

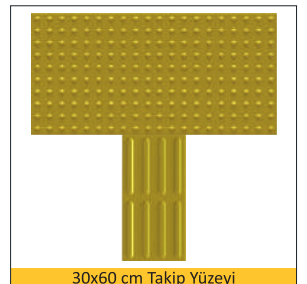

30x60 cm Takip Yüzeyi

Ürün Teknik Özellikleri

Kod	PL 8018	PL 8019
Ölçü(HxLxW) ±%5	0.8x58x58 cm	0.8x58x58 cm
Ağırlık ±%5	1.40 kg	1.40 kg
Malzeme	TPU	TPU
Montaj	EPOKSİ	

- » İç ve dış ortam şartlarına dayanıklı TPU malzemeden üretilmiştir.
- » Kolay temizlenebilir, kaydırmaz yüzey
- » Kullanılan mekanlarda ortama uyumlu kontrast renk seçenekleri
- » Zemine uygun epoksi yapıştırıcı ile uygulanmalıdır.

Yapışkanlı Zemin Uyarı İşaretleri



PL 5012-Y



PL 5014-Y



PL 5017-Y



PL 5018-Y

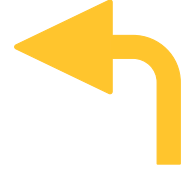

PL 5015-Y

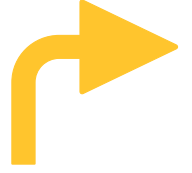

PL 5016-Y

Ürün Teknik Özellikleri

Kod	PL 5012-Y	PL 5014-Y	PL 5017-Y	PL 5018-Y	PL 5015-Y	PL 5016-Y
Ölçü	(H)100cm	(HxL)300x100cm	(HxL)300x100cm	(HxL)300x100cm	(HxL)175x175cm	(HxL)175x175cm

Yapışkanlı Zemin Uyarı İşaretleri

DUR

PL 5030-Y



PL 5040-Y
Yaya Geçidi Çizgisi

Ürün Teknik Özellikleri

Kod	PL 5030-Y	PL 5040-Y
Ölçü	(H)100cm	(HxL)35x200cm



Ürün Teknik Özellikleri

- » esnek dokulu, cam kürecikli, yüksek performanslı yansıtıcı yüzey
- » dış şartlardan etkilenmeyen kuvvetli yapışkan tabaka
- » kullanım alanı: otoparklarda, yaya alanlarında, sosyal alanlarda, fabrikalar, AVM ler, stadyumlar, fuar holleri, hastaneler, kompleks bina bahçeleri, havaalanı, liman vb. sahalarda, yön bildirme amacıyla tüm iç ve dış mekanlarda

PL 5012-Y / PL 5014-Y / PL 5017-Y / PL 5018-Y
PL 5015-Y / PL 5016-Y / PL 5030-Y / PL 5040-Y

Reflektif Bant Özellikleri

Kalınlık (mm)	1.5	GB/T 7125	Test Yöntemi
Yapışkanlık (N/25 cm)	16	GB/T 24717-2009	
Geri yansımaya (mcd/lx.m ²)	250	GB/T 24717-2009	
Renk	Sarı		

- » İşlem esnasında tavsiye edilen ortam sıcaklığı min. +5°C max.40°C dir
- » uygulama yüzeyi beton zemin veya benzer yüzeyde olmalıdır, çok pütürlü yüzeyler tavsiye edilmez
- » uygulama yüzeyi yağdan ve tozdan arındırılmış olmalıdır
- » kuru ve temiz yüzeye, resme göre uygulanmalıdır
- » uygulamadan hemen sonra kullanıma hazırdır

Yapışkanlı Zemin İşaretleme Bantları

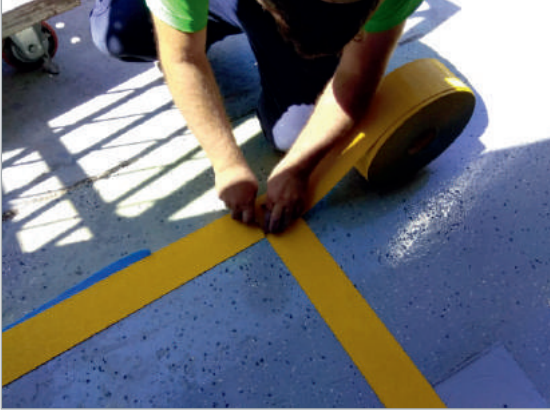

PL 5001



PL 5002



5 cm x 33 m/roll



10 cm x 33 m/roll

Ürün Teknik Özellikleri

Kod	PL 5001	PL 5002
Ölçü	5 cmx33 m/roll	10 cmx33 m/roll

Yapışkanlı Zemin İşaretleme Bantları



PL 10001

PL 10002



5 cm x 33 m/roll

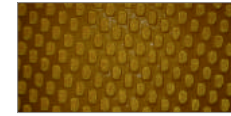

10 cm x 33 m/roll

Ürün Teknik Özellikleri

Kod	PL 10001	PL 10002
Ölçü	5 cmx33 m/roll	10 cmx33 m/roll

Ürün Teknik Özellikleri

PL 5001 / PL 5002
PL 10001 / PL 10002

- » esnek dokulu, cam kürecikli, yüksek performanslı yansıtıcı yüzey
- » dış şartlardan etkilenmeyen kuvvetli yapışkan tabaka
- » kullanım alanı: otoparklarda, yaya alanlarında, sosyal alanlarda, fabrikalar, AVM ler, stadyumlar, fuar holleri, hastaneler, kompleks bina bahçeleri, havaalanı, liman vb. sahalarda, yön bildirme amacıyla tüm iç ve dış mekanlarda
- » İşlem esnasında tavsiye edilen ortam sıcaklığı min. +5°C max.40°C dir
- » uygulama yüzeyi beton zemin veya benzer yüzeyde olmalıdır, çok pütürlü yüzeyler tavsiye edilmez
- » uygulama yüzeyi yağdan ve tozdan arındırılmış olmalıdır
- » kuru ve temiz yüzeye, resme göre uygulanmalıdır uygulamadan hemen sonra kullanıma hazırdır

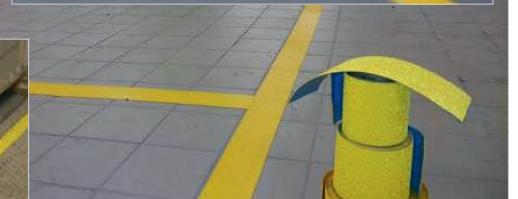
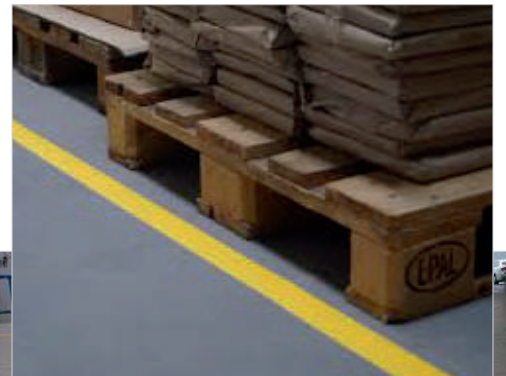
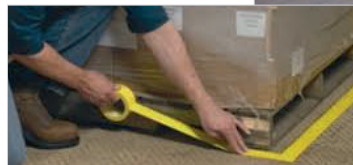

Reflektif Bantlar



ETR 5111



ETR 5112



ETR 5115



ETR 5116



ETR 5121



ETR 5122

Ürün Teknik Özellikleri

Kod	ETR 5111	ETR 5112	ETR 5115	ETR 5116	ETR 5121	ETR 5122
Renk	Kırmızı-Beyaz	Kırmızı-Beyaz	Kırmızı-Sarı	Kırmızı-Sarı	Sarı-Siyah	Sarı-Siyah
Ölçü	5cmx10m/rulo	10cmx10m/rulo	5cmx10m/rulo	10cmx10m/rulo	5cmx10m/rulo	10cmx10m/rulo
Tip	Cam Kürecikli	Cam Kürecikli	Cam Kürecikli	Cam Kürecikli	Cam Kürecikli	Cam Kürecikli



EGR 001



EGR 003

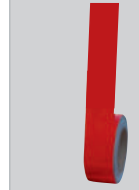

EGR 007



ETR 5131



ETR 5141



ETR 5151



ETR 5161

Ürün Teknik Özellikleri

Kod	EGR 001	EGR 003	EGR 007	ETR 5131	ETR 5141	ETR 5151	ETR 5161
Renk	Beyaz	Sarı	Kırmızı	Beyaz	Sarı	Kırmızı	Mavi
Ölçü	5cmx30m/rulo	5cmx30m/rulo	5cmx30m/rulo	5cmx10m/rulo	5cmx10m/rulo	5cmx10m/rulo	5cmx10m/rulo
Geri Yansımaya	400 cd/lux	300 cd/lux	70 cd/lux	-	-	-	-
Tip	Mikroprizmatik	Mikroprizmatik	Mikroprizmatik	Cam Kürecikli	Cam Kürecikli	Cam Kürecikli	Cam Kürecikli

Ürün Teknik Özellikleri

- » esnek dokulu, cam kürecikli, yüksek performanslı yansıtıcı yüzey
- » dış şartlardan etkilenmeyen kuvvetli yapışkan tabaka
- » kullanım alanı: otoparklarda, yaya alanlarında, sosyal alanlarda, fabrikalar, AVM ler, stadyumlar, fuar holleri, hastaneler, kompleks bina bahçeleri, havaalanı, liman vb. sahalarda, yön bildirme amacıyla tüm iç ve dış mekanlarda
- » İşlem esnasında tavsiye edilen ortam sıcaklığı min. +5°C max.40°C dir
- » uygulama yüzeyi beton zemin veya benzer yüzeyde olmalıdır, çok pütürlü yüzeyler tavsiye edilmez
- » uygulama yüzeyi yağdan ve tozdan arındırılmış olmalıdır
- » kuru ve temiz yüzeye, resme göre uygulanmalıdır
- » uygulamadan hemen sonra kullanıma hazırdır



Dikdörtgen Uyarı Levhaları-41x35 cm



317 A R



316 A R



315 A R



314 A R



308 A R

Ürün Teknik Özellikleri

Kod	317 A R	316 A R	315 A R	314 A R	308 A R
Ölçü(HxL) ±%5	41x35 cm	41x35 cm	41x35 cm	41x35 cm	41x35 cm
Malzeme	PPC	PPC	PPC	PPC	PPC
Reflektif Performansı	30 cd/lux	30 cd/lux	30 cd/lux	30 cd/lux	30 cd/lux

Dikdörtgen Uyarı Levhaları-41x35 cm



309 A R



310 A R



311 A R



312 A R



325 A R (İki Yönde Uyarı)



326 A R

Ürün Teknik Özellikleri

Kod	309 A R	310 A R	311 A R	312 A R	325 A R	326 A R
Ölçü(HxL) ±%5	41x35 cm	41x35 cm	41x35 cm	41x35 cm	41x35 cm	41x35 cm
Malzeme	PPC	PPC	PPC	PPC	PPC	PPC
Reflektif Performansı	30 cd/lux	30 cd/lux	30 cd/lux	30 cd/lux	30 cd/lux	30 cd/lux

Üçgen Uyarı Levhaları-H 39 cm



130 A R



131 A R



135 A R



Ürün Teknik Özellikleri

Kod	130 A R	131 A R	135 A R
Ölçü(H) ±%5	39cm	39cm	39cm
Malzeme	PPC	PPC	PPC
Reflektif Performansı	30 cd/lux	30 cd/lux	30 cd/lux

Üçgen Uyarı Levhaları-H 39 cm



132 A R



133 A R



134 A R

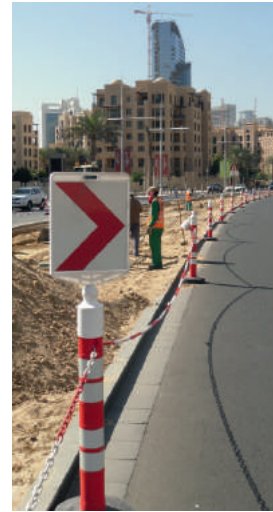

Ürün Teknik Özellikleri

Kod	132 A R	133 A R	134 A R
Ölçü(H) ±%5	39cm	39cm	39cm
Malzeme	PPC	PPC	PPC
Reflektif Performansı	30 cd/lux	30 cd/lux	30 cd/lux

Yuvarlak Uyarı Levhaları-Ø38 cm

222 A R
(İki Yönde Uyarı)

229 A R



230 A R



234 A R



221 A R



239 A R



233 A R

295 A F
(İki Yönde Uyarı)

Ürün Teknik Özellikleri

Kod	222 A R	229 A R	230 A R	234 A R	221 A R	239 A R	233 A R	295 A F
Ölçü(Ø) ±%5	38cm	38cm	38cm	38cm	38cm	38cm	38cm	38cm
Malzeme	PPC	PPC	PPC	PPC	PPC	PPC	PPC	PPC
Reflektif Perf.	30 cd/lux	30 cd/lux	30 cd/lux	30 cd/lux	30 cd/lux	30 cd/lux	30 cd/lux	30 cd/lux

Uyarı Levhaları

111 A
Dikdörtgen
Levha110 A
Üçgen
Levha196 A
Ultra Yuvarlak
Levha120 A
Yuvarlak
Levha124 A F
Park Yasak Levhası
(İki Yönde Uyarı)113 A
Yıldız
Levha114 A
Dekoratif
Levha

Ürün Teknik Özellikleri

Kod	111 A	110 A	196 A	120 A	124 A F	113 A	114 A
Ölçü ±%5	(HxL)41x35cm	(H)39cm	(Ø)38cm	(Ø)28cm	(Ø)28cm	(HxL)30x30cm	(HxL)34x32cm
Malzeme	PPC	PPC	PPC	PPC	PPC-Folyo	PPC	PPC

Aksesuarlar

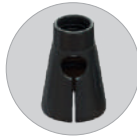
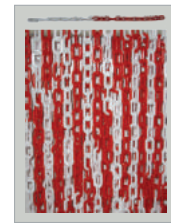
174 A
Zincir
Kancası194 A
Ø80 Delinatör
Lamba Aparatı126 A
Koni Lamba ve Levha
Aparatı175 A
Zincir Klipsi190 A
PVC Koni Ağırlığı
(5 kg)

128 A

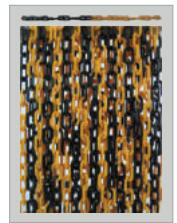

129 A



152 A R Koni ve Dikme Barikat Profili

127 A
Plastik Zincir 3m
Klipsli

123 A

Ürün Teknik Özellikleri

Kod	174 A	194 A	126 A	175 A	190 A	128 A	129 A	127 A	123 A	152 A R
Ölçü ±%5	Ø4cm	Ø 8cm	(H)10.5cm	(Ø)0.7cm	(HxLxW)5x38x38	25 m	25 m	3 m	3 m	(L)150cm
Malzeme	PPC	PPC	ABS	PPC	PVC	PPC	PPC	PPC	PPC	PVC

Aksesuarlar

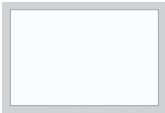
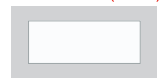
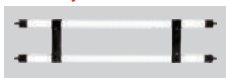
164 A
PVC Levha(3mm)149 A
Bariyer Levha Profili142 A
PVC Levha(3mm)150 A
Bariyer Levha Profili159 A
16x90 mm
Dübel
10x100 mm
Flanşlı
Trifon Vida163 A
14x70 mm
Dübel
10x80 mm
Flanşlı
Trifon Vida160 A
14x70 mm
Dübel
7.5x80 mm
Buldex Vida176 A
10x100 mm
Flanşlı
Trifon Vida161 A
5.5x105 mm
Burgulu Çivi173 A
14x70x8 mm
Dübel172 A
16x90x10 mm
Dübel

155 A

Dikme Profil Kancası

Ürün Teknik Özellikleri

Kod	164 A	149 A	142 A	150 A	155 A	159 A	163 A	160 A	176 A	161 A	173 A	172 A
Ölçü	(HxL)75x125	(HxL)75x150	(HxL)31.5x90	(HxL)31.5x150	(Ø)11cm	-	-	-	-	-	-	-
Malzeme	PVC	PVC	PVC	PVC	PPC	PPC / ST	PPC / ST	PPC / ST	ST	ST	PPC	PPC



0312 504 1 500 - 0532 723 57 87
info@ostimetiket.net - www.ostimetiket.net
100. Yıl Blv. No: 38/C Ostim - Yenimahalle / Ankara